



Anywhere Anytime Communications

*A practitioner point of view
about Resilience in large
ubiquitous systems*

Michele Morganti

ReSIST Summer School – Porquerolles Island – September 2007

Presentation outline



❖ From PSTN to NGN

- Technological and architectural evolution of public telecommunication infrastructures

❖ Public Communications Resilience Today

- The impact of market liberalization and re-regulation on the dependability of public networks and on their resilience to catastrophic events

❖ Beyond NGN

- Emerging trends and relevant challenges

❖ Summary and conclusions

From PSTN to NGN

50 years of parallel convergences

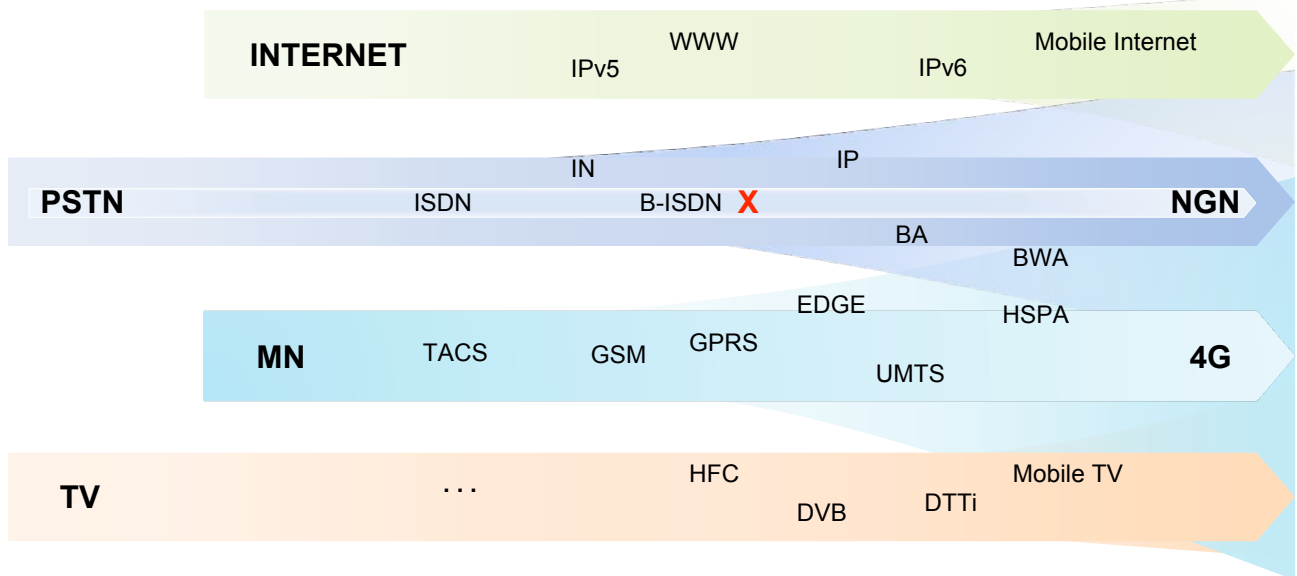



10/09/07

3

PSTN Reference Architecture (until 1980's)

Once upon a time



-  Transit nodes
-  Local nodes
-  Concentrators

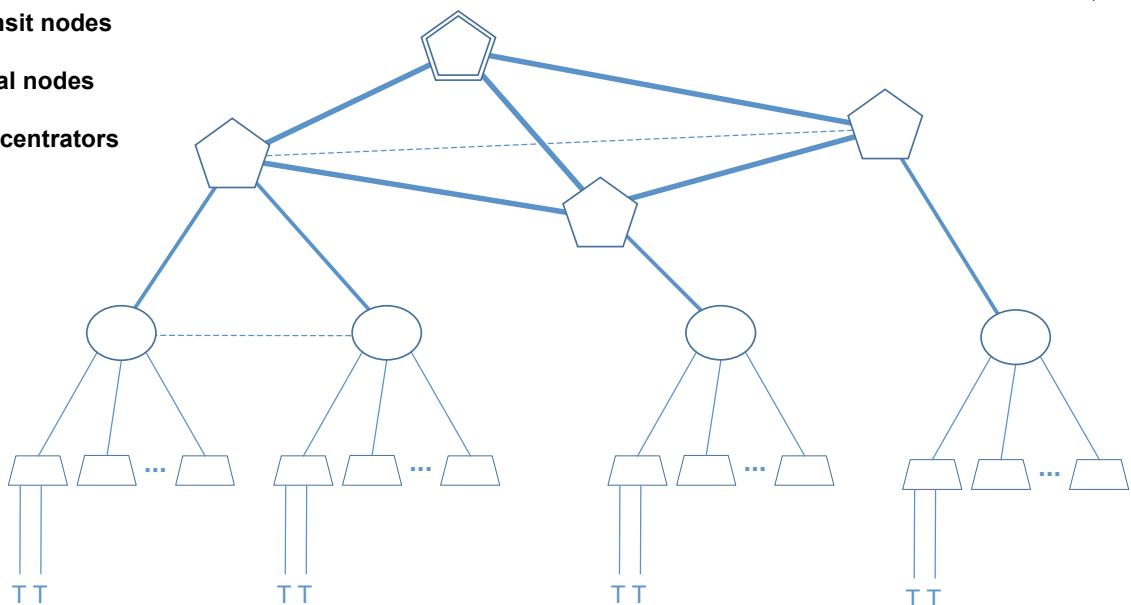

10/09/07

4

PSTN Key Characteristics (until 1950's)

Setting the standard



❖ Architecture & Technology

- Few, well established technologies (*single circuit electromechanical cross-points, copper pairs, in-band signaling, fully distributed control*)
- Huge number of few, well defined element types organized into simple, strictly hierarchical sub-networks (*fully autonomous and self-contained, including powering and terminals*)
- No explicit architectural redundancy but most failures affecting single circuits only
- Some resilience to major infrastructural damages through network partitioning

❖ Market & Regulation

- Single, well known, and fully specified service (*POTS*)
- Tight and challenging self-imposed standards (*strong technology drive*)
- Highly (*and often self*) regulated monopolies (*weak market drive*)

10/09/07

5

PSTN Technological Evolution (1950's through 1980's)

Keeping up with times

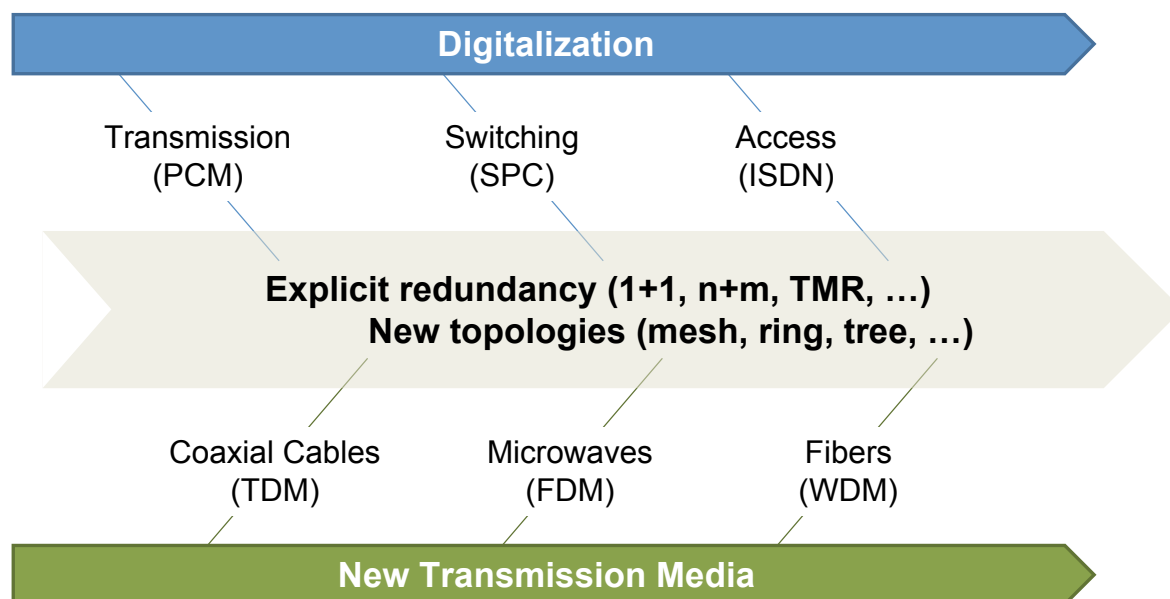

10/09/07

6

PSTN Key Characteristics (until 1980's)

Sticking to the standard



❖ Architecture & Technology

- Several new technologies (*coding, multiplexing, processors, memories, fibers, lasers, etc.*), but mainly used to emulate older ones
- Huge number of few, well defined element types organized into simple, strictly hierarchical sub-networks (*fully autonomous and self-contained, including powering and terminals*)
- Some architectural redundancy but overall dependability mainly based on high availability/redundancy of individual network elements
- Some resilience to major infrastructural damages through network partitioning

❖ Market & Regulation

- Other than voice payloads, but handled transparently over digitized voice channels (*POTS like circuit switching*)
- Tight and challenging self-imposed standards (*strong technology drive*)
- Highly (*and often self*) regulated monopolies (*weak market drive*)

10/09/07

7

IN Reference Architecture (since 1980's)

Innovating within the tradition

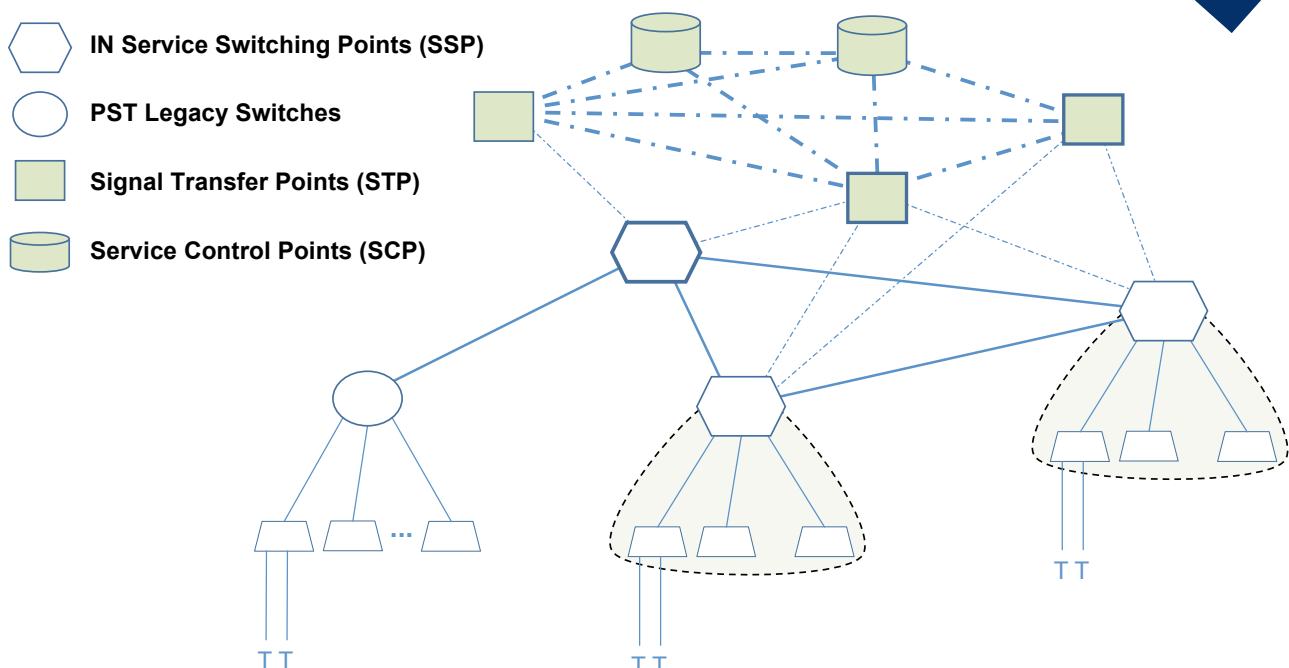

10/09/07

8

IN Key Characteristics (since 1980's)

Re-setting the standard



❖ Architecture & Technology

- Out of band SS7 signaling, enabling new and enriched telephony services
- Separate infrastructures based on different architectural principles for service delivery (telephonic circuits) and service control (SS7 signaling)
- Explicit architectural redundancy of all signal handling elements
- Resilience through plain network partitioning in the presence of major infrastructural damages no more guaranteed

❖ Market & Regulation

- Other than voice payloads, but handled transparently over digitized voice channels (*POTS like circuit switching*)
- Tight and challenging self-imposed standards (*strong technology drive*) with **national flavorings** (*interoperability becomes an issue*)
- Highly (*and often self*) regulated monopolies (*weak market drive*)

10/09/07

9

GSM Reference Architecture (since 1990's)

Communications go mobile



MS = Mobile Station

SIM = Subscriber Identity Module

BTS = Base Transceiver Station

BSC = Base Station Controller

MSC = Mobile Switching Center

VLR = Visitor Location Register

OMC = Operation and Maintenance Center

NMC = Network Management Center

HLR = Home Location Register

EIR = Equipment Identity Register

AC = Authentication Center

NMC = Network Management Center

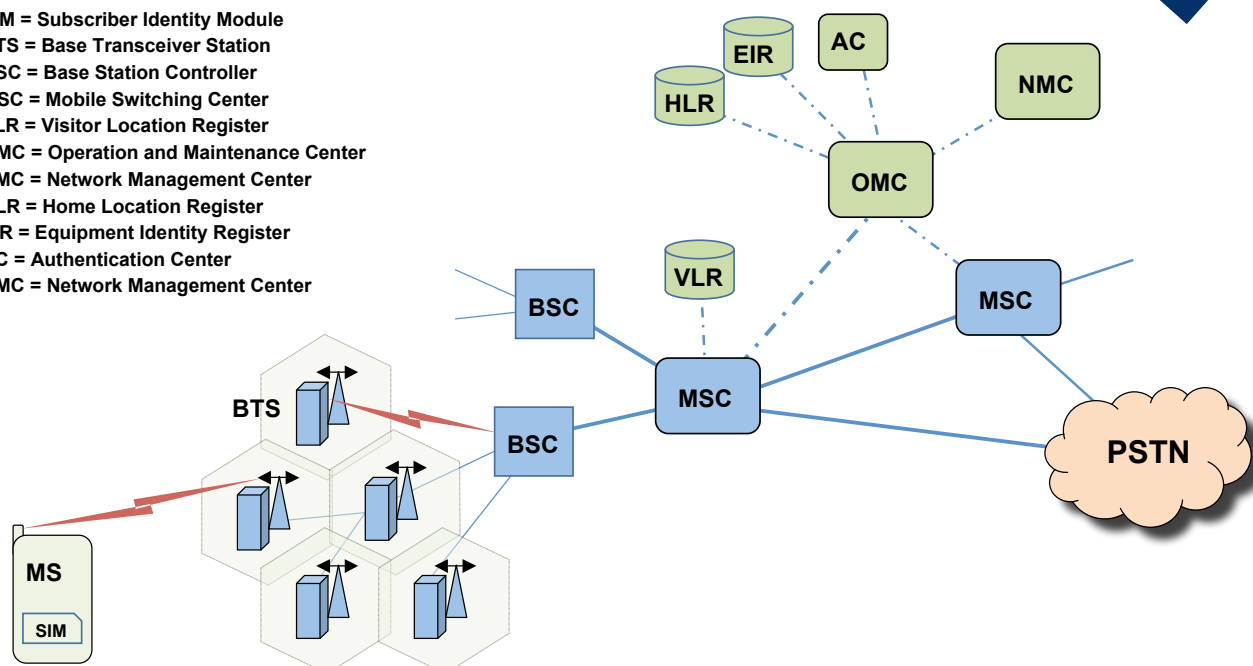

10/09/07

10

GSM/GPRS Reference Architecture (since late 1990's)

Mobile packet data



MS = Mobile Station

SIM = Subscriber Identity Module

BTS = Base Transceiver Station

BSC = Base Station Controller

MSC = Mobile Switching Center

VLR = Visitor Location Register

OMC = Operation and Maintenance Center

NMC = Network Management Center

HLR = Home Location Register

EIR = Equipment Identity Register

AC = Authentication Center

NMC = Network Management Center

SGSN = Serving GPRS Support Node

GGSN = Gateway GPRS Support Node

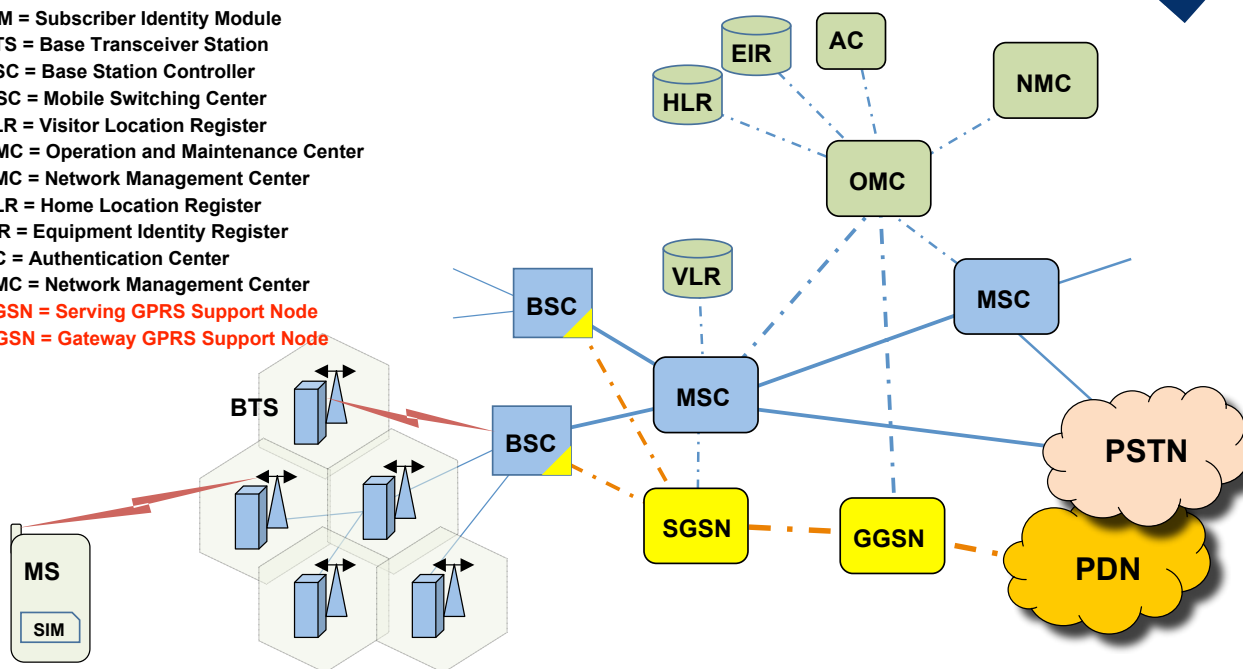

10/09/07

11

MN Key Characteristics (since 1990's)

Going to Market



❖ Architecture & Technology

- Further evolution of the IN concept (*all calls, SIM/MS separation, etc.*), and significant shift of network intelligence (*and relevant costs*) to terminals
- Separate cores for circuits, packets and signaling (*one access, many cores*); fewer nodes but more node types featuring explicit architectural redundancy
- Perceived QoS and overall resilience to unplanned events largely dependent on quality and extension of radio access coverage

❖ Market & Regulation

- Growing variety of services (*voice, messaging, data, LBS, etc.*), circuit, packet and IN based (*Convergence no more an abstract concept*)
- Cell based wireless access and radio feeding of BTS's dramatically reduce deployment times and costs (*end of the "natural monopoly" commonplace*)
- Very competitive and liberalized market with less stringent regulations and numerous new entries (*very strong market and financial drives*)
- Standards mainly focusing on interoperability issues; QoS directly linked to costs and prices (*much weaker technology and regulation drives*)

10/09/07

12

The Great B-ISDN Depression (mid 1990's)

In the meantime ...



❖ Some of the reasons behind the crash

- Architectural approach identical to (N-)ISDN (*one access, one core, any service*)
- Many first time technologies (*ATM, WDM, PON, etc.*) backed by many naïve assumptions (*video coding at 155Mb/s, all symmetrical ATM traffic, etc.*)
- Totally unrealistic market assumptions with excessive emphasis on superior performance and QoS guarantee:
 - *Arrogantly discarding the MN and Internet lessons*
 - *Intentionally ignoring the mounting pressure for liberalization*

❖ Some key consequences of the crash

- For the national operators: worse possible positioning in front of the upcoming liberalization of the telecommunication market
- For the manufacturers: loss of huge investments made on B-ISDN and immediate freeze, followed by severe downsizing, of all R&D projects
- For all: mindless “gold rush” on everything bearing an “Internet” tag

10/09/07

13

The End of the Monopoly Era (late 1990's)

New games, new rules, new players



❖ The consequences of liberalization, privatization and competition

- Market and financials replace technology and standards as main drives; regulations remain important but with a totally different focus
- Short term dominates over long term in all respects; assets and experience become legacies with mainly negative implications
- The balanced evolution of offer and demand leads to a progressive segmentation of the market; the high QoS standards set during the monopoly times are eventually confined to a small upper niche

❖ The MN and Internet lessons

- Customers value more getting what they want than the way they get it or even the quality of it
- As long as they don't have to pay there's nothing they'd be ready to give-up; when asked to, however, there's almost nothing that they couldn't
- The freedom to choose is often perceived by customers as more important than the actual existence of a choice

10/09/07

14

Fixed Broadband (late 1990's)

Staying alive



❖ Technology and Architecture

- Overlay architecture borrowed from GSM/GPRS (*broadband traffic separated at first access node; separate cores for packets and circuits*)
- Many technologies imported from other areas (*ADSL, HFC, IP, DWDM, etc.*)
- Very limited knowledge of emerging traffic profiles and users' behavior
- No precise requirements nor clear standards to follow

❖ Market and Regulation

- BB Data not really a service but rather a way of keeping some control on the fast growing demand for broadband Internet access
- Mainly "Try & Cut" approach to market because of poor understanding of customer needs and motivations
- Continuously evolving regulations and competitive scenario, because of ongoing market liberalization
- Many newcomers, with no experience and no legacies, mainly driven by financial objectives and constraints

10/09/07

15

Broadband Wireless Access (mid 2000's)

Fixed goes wireless



❖ Technology and Architecture

- Advanced wireless access technology (*low power, cellular coverage, smart antennas, lightweight terminals, OFDMA, IP native, etc.*) originally conceived to fill the gap between fixed and mobile (*and largely overlapping with both*)
- Complementary to W-LAN, xDSL and FITL, as well as to DTTV and Mobile TV (*and easy to integrate with all of them*)
- Easy, fast and relative inexpensive to deploy and integrate into existing network infrastructures (*fixed, mobile and even TV*)
- Could be easily evolved into both NGN and 4G, but relevant role and positioning not yet completely assessed nor generally accepted

❖ Market and Regulation

- Positive response and great expectations by customers, regulators and most operators; cautious response and some opposition mainly by dominant (*fixed*) and other well established (*mainly mobile*) operators
- Full exploitation of the BWA potential requires substantial re-regulation of current spectrum assignment and management criteria

10/09/07

16

BWA Technology (WiMAX)

LOS/NLOS coverage capability ...

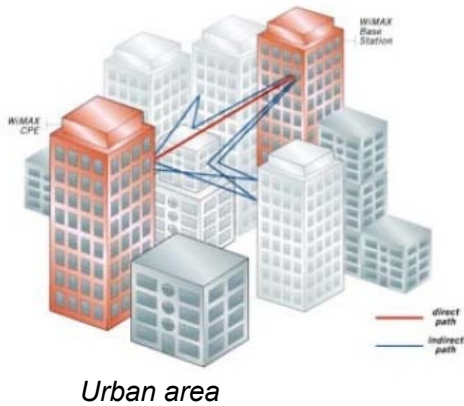

Urban area



Rural area

❖ WiMAX technology, solves or mitigates the problems resulting from NLOS conditions by using:

- OFDM technology
- Sub-Channelization
- Directional antennas
- Transmit and receive diversity
- Adaptive modulation
- Error correction techniques
- Power control

LOS
30 to 50 km
NLOS
4 to 9 km
Indoor Self-install
1 to 2 km

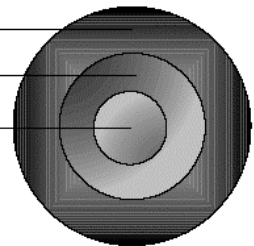

Full featured cell radii

BWA Technology (WiMAX)

Naturally complementing WiFi

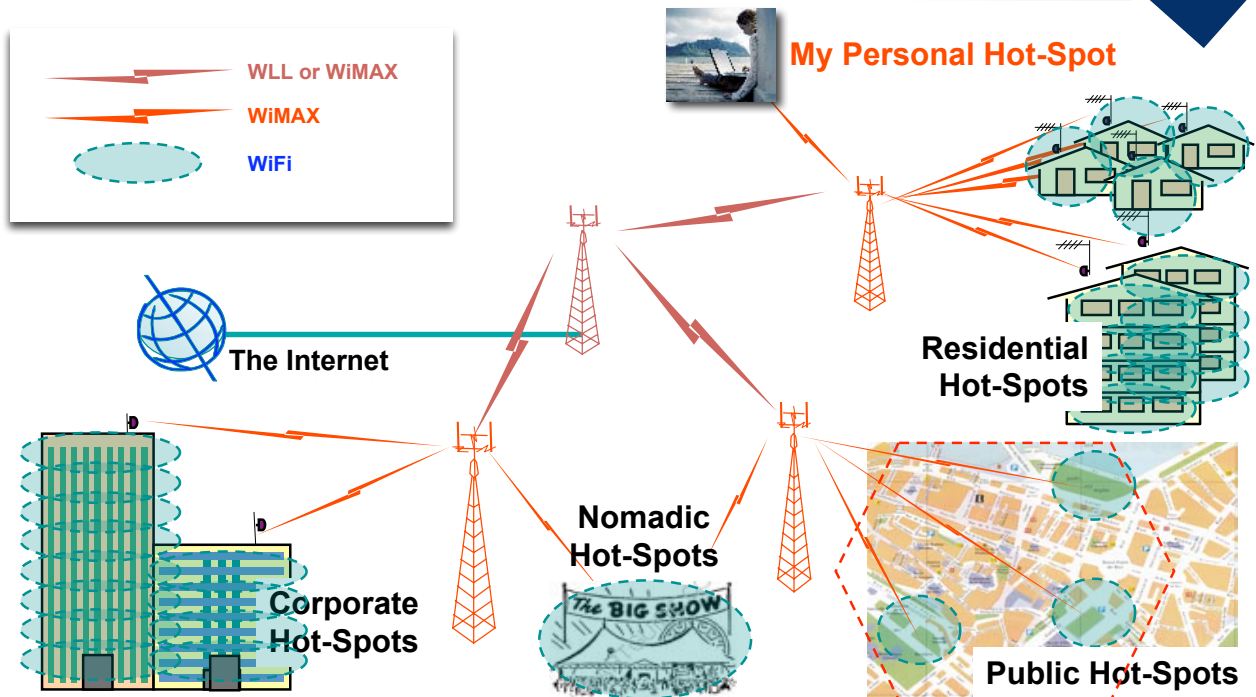

Evolutionary NGN-A All-IP Architecture

Any access, one protocol

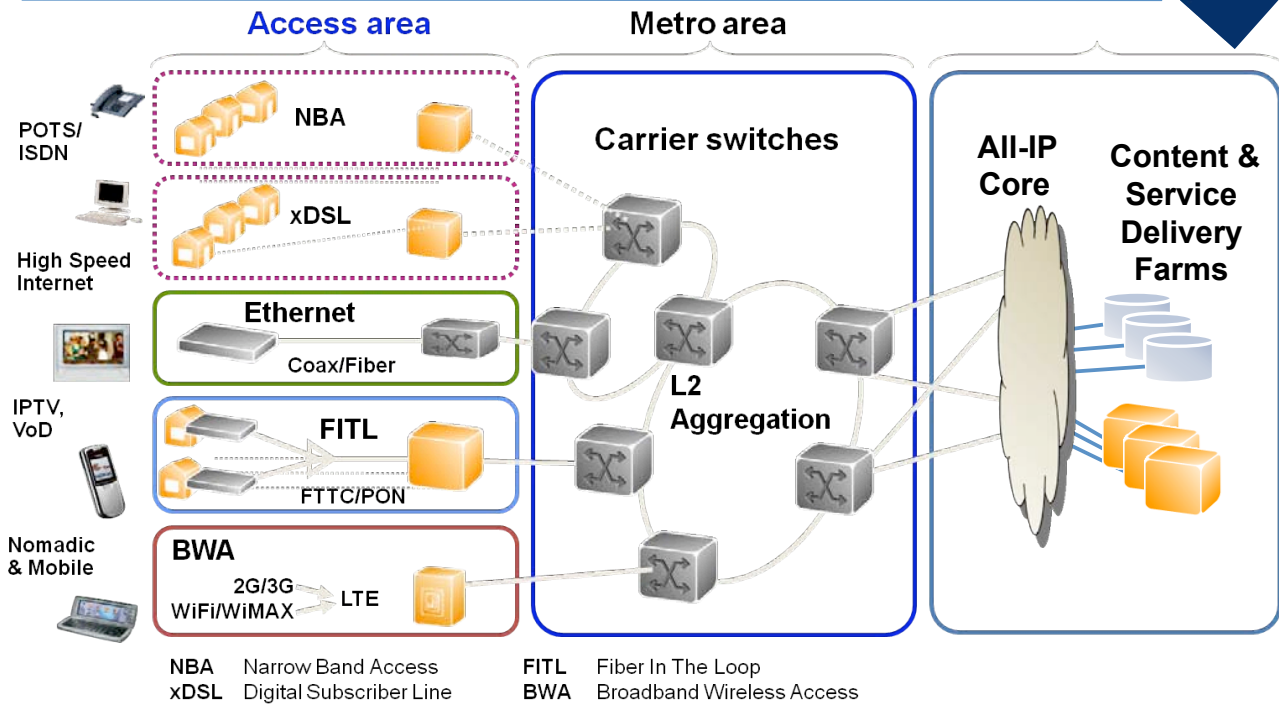

10/09/07

19

Towards NGN (by 2010 ?)

Any service, one network

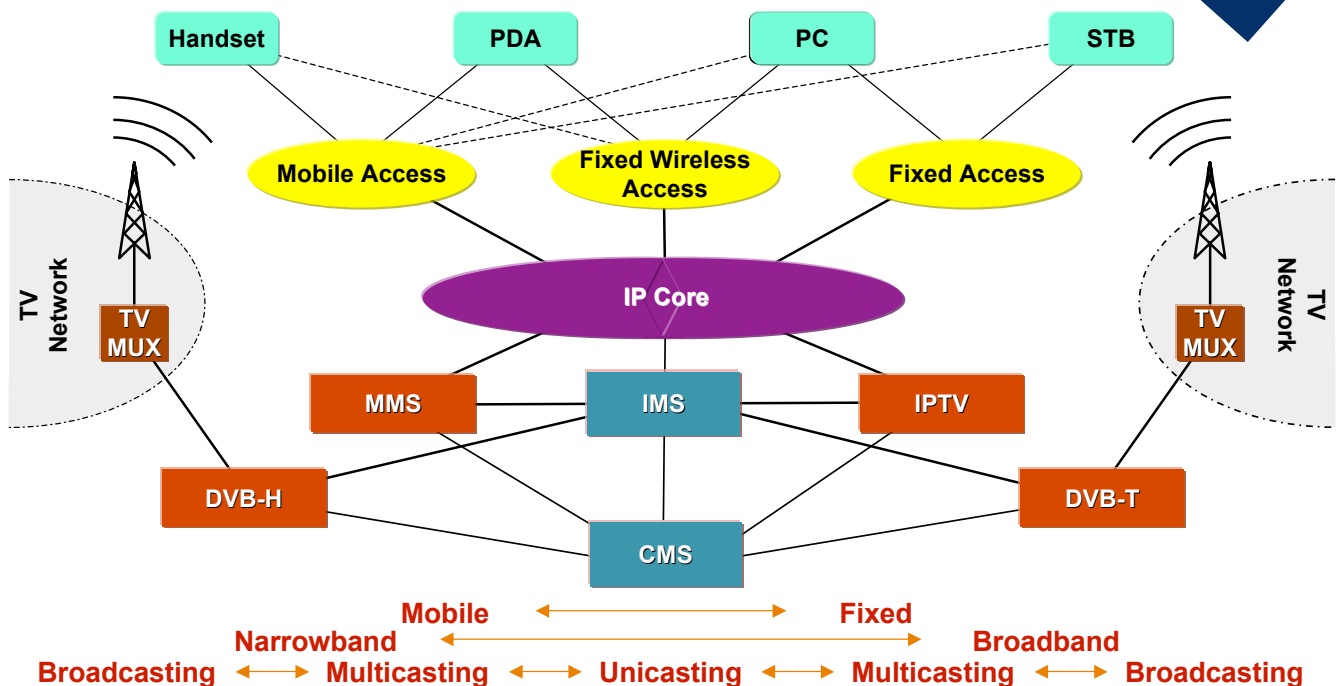

10/09/07

20

IMS Architecture

Any data, one instance ...

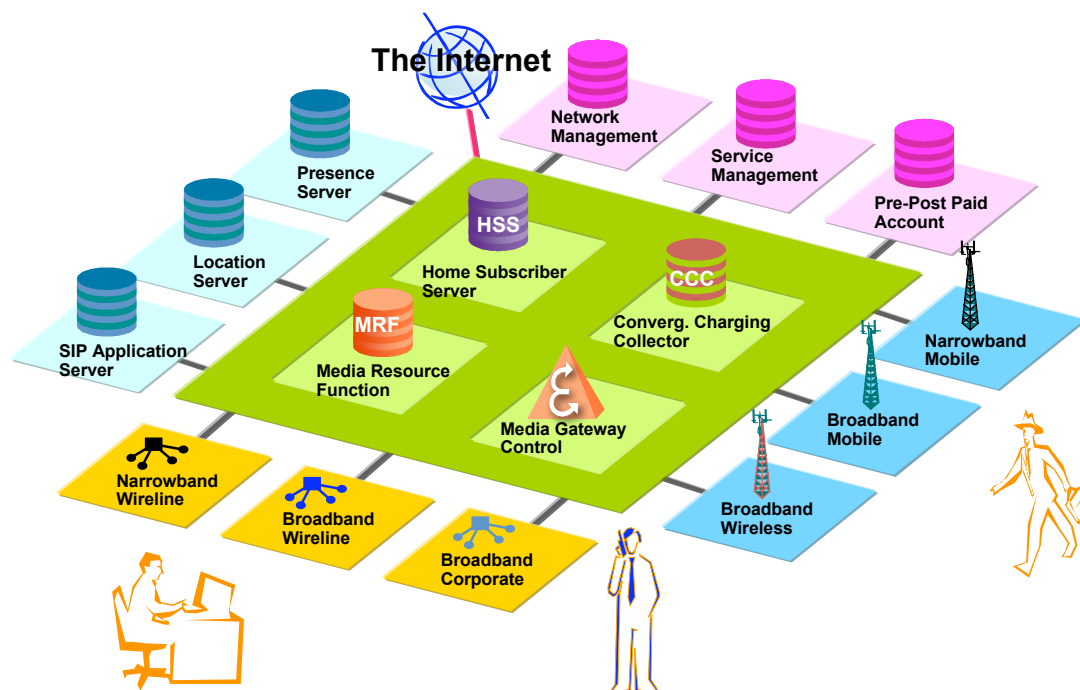

10/09/07

21

Towards NGN (mid 2000's)

Convergence, maybe ...



❖ Technological and Architectural Pluses

- Provides a conceptual framework for integrating, through IP, a variety of existing and future technologies and services into a single network
- Maximum flexibility for the owner of the infrastructure to configure it (*by including or excluding specific subsystems*) according to his own unique needs and scope of business

❖ Technological and Architectural Minuses

- Sub-optimal solutions for single service, vertically integrated networks
- Operator centric business model, not suited for vertical nor horizontal segmentation of business roles
- Architectural efficiency and scalability with respect to the expected growth of peer-to-peer and non-intermediated services not evident
- Complexity of cross adaptation of services and contents across an unbound variety of network and terminal technologies could grow exponentially
- **Possibly, just one more attempt to revive the “telephonic paradigm” ...**

10/09/07

22

Public Communications Resilience Today

What happened to the legendary dependability of PSTN ?

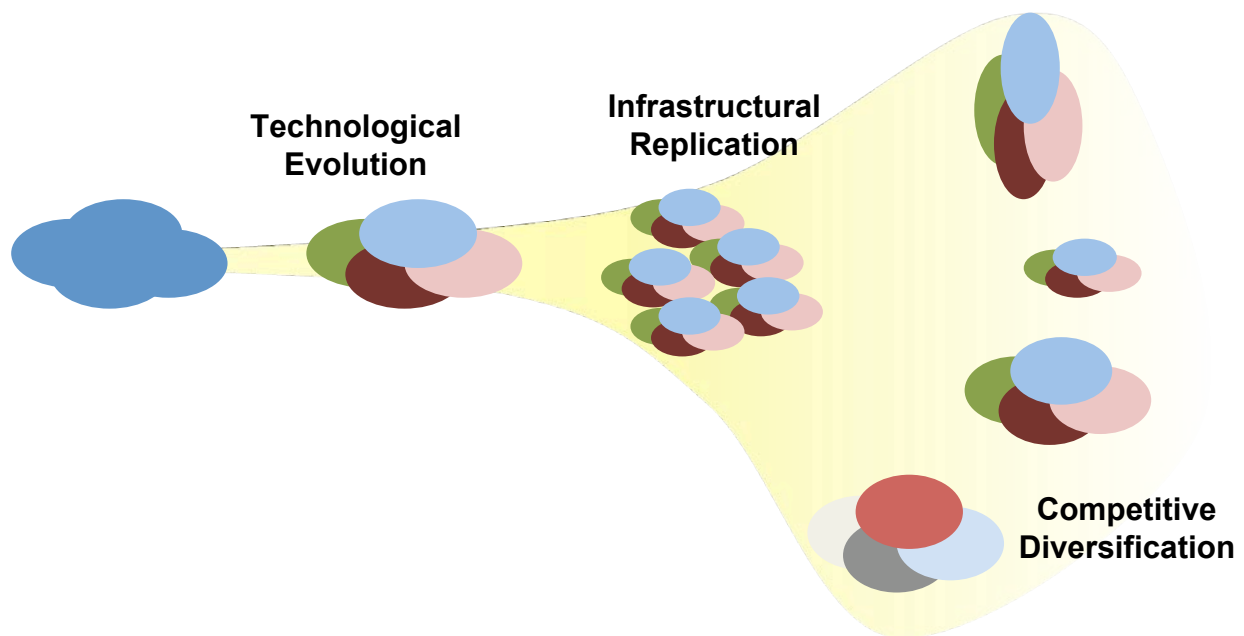

10/09/07

23

Technological Evolution and Resilience

From fully distributed dumbness to centralized intelligence



- Digitalization and coding introduce additional sources of failure, however largely compensated by better signal quality (*noise filtering, error correction, etc.*)
- Multiplexing makes single failures affect multiple circuits requiring explicit redundancy of or within relevant network elements (*e.g. trunk duplication*)
- Stored Program Control introduces further sources of failure that could affect entire nodes and sub-networks, thus requiring more sophisticated redundancy schemes (*self diagnosis, fault-location, forward and backward recovery, etc.*).

Software eventually becomes the main source of failures

- IN introduces common sources of failure that could simultaneously affect an entire network, thus requiring the introduction of explicit architectural redundancy and of recovery schemes allowing for partial degradation (*e.g. emergency services only*)
- In MN the intrinsic variability of cellular radio coverage becomes the dominant source of poor service quality, thus hiding the effects of most other sources of failure

High dependability eventually becomes an option (as in GSM-R)

- Both IN and MN collect and store large quantities of sensitive data (*user profile, user location, payment information, etc.*) that need adequate protection

Information security and users' privacy do become an issue

10/09/07

24

Infrastructural Replication and Diversification

From one ultra-reliable network to many less reliable ones



- Obligations associated with licensing (*especially when involving spectrum assignment*) lead to the building of a multiplicity of independent (MN) infrastructures
 - *Relaxation of regulations to reduce entry barriers and foster competition through diversification cause a significant lowering of QoS requirements and standards*
- Privatization and liberalization lead to the entry of new actors and new capitals, most with a much higher market and business orientation than past monopolists
 - *Financial drives do not incentive infrastructural investments unless directly associated with clear short term profits*
- Market pressure and growing competition oblige operators to continuously diversify and differentiate their offerings, thus also fostering technological innovation
 - *Margin erosion and price competition oblige them to regard high QoS as just one of many optional features, that need to be justified by proved willingness to pay*
- Unbundling, wholesale, hosting and other emerging infrastructure sharing practices force operators to agree and comply with more stringent service level agreements
 - *Towards customers, they provide easy justification for keeping the responsibility barrel rolling in case of malfunctions and poor QoS*

10/09/07

25

Towards N-Instances, N-Versions Based Resilience

A growing role for multi-standard, multi-operator terminals

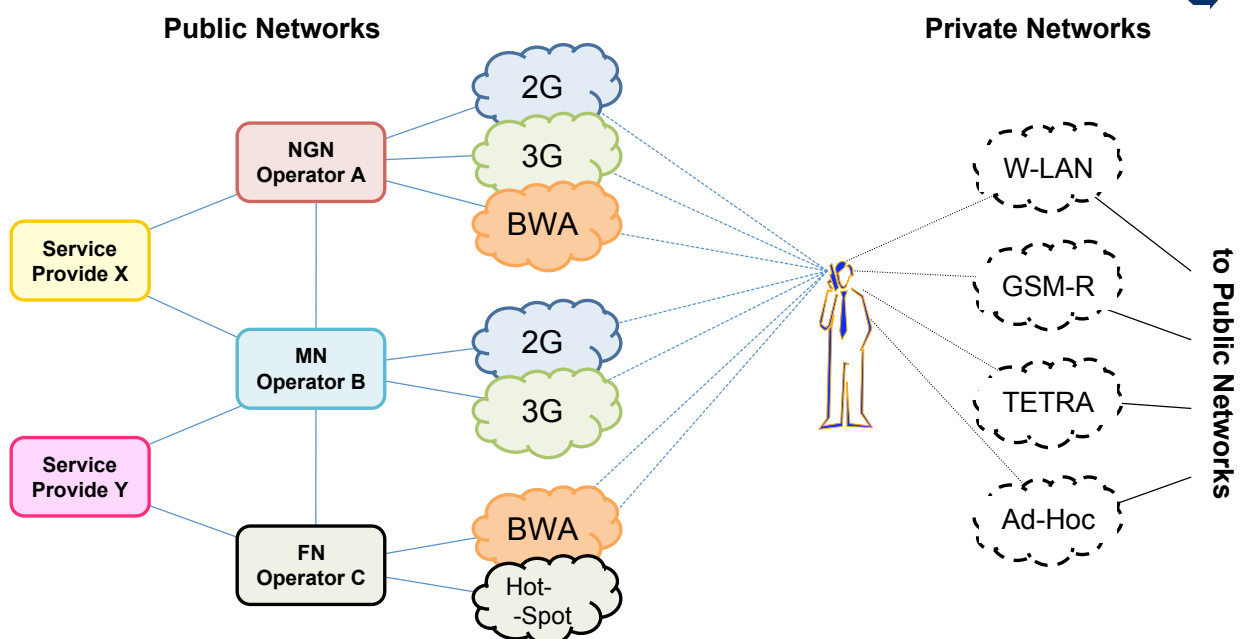

10/09/07

26

Environmental Emergencies

Space and time dimensions of catastrophic events

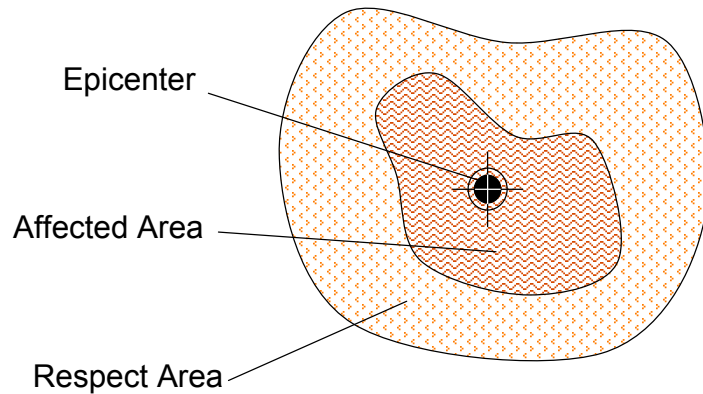

Event Types

- Earthquakes, Tsunamis
- Floods, Fires, Landslides
- Hurricanes, Tornadoes, Snowstorms
- Toxic fumes and wastes, Radioactive leaks
- Terrorist attacks (NBC)
- ...

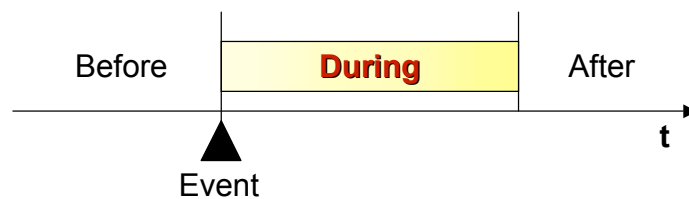

Environmental Emergencies

People and communication flows in emergency hit areas



Subject Groups

- Residents
- Police
- Emergency forces, (local & external)
- Volunteers
- Relatives and friends
- Media
- Curious
- Ill intentioned
- ...

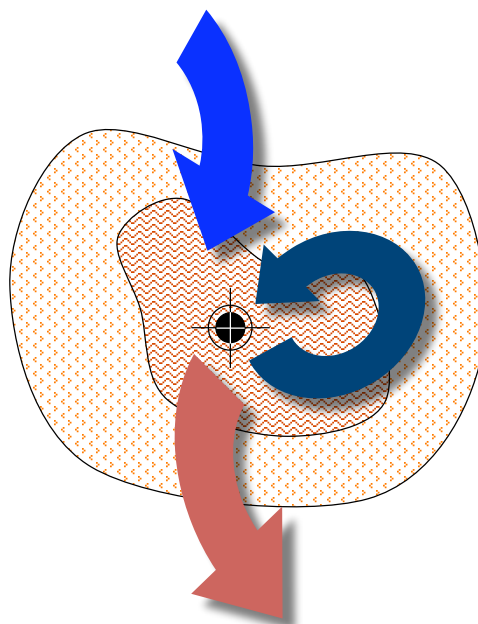

Relevant I&C Needs

- With, within and between "groups"
- Who is there and where they are
- Who enters and who exits
- What are their duties
- What are their needs
- ...

Environmental Emergencies

Available communication infrastructures and relevant reach

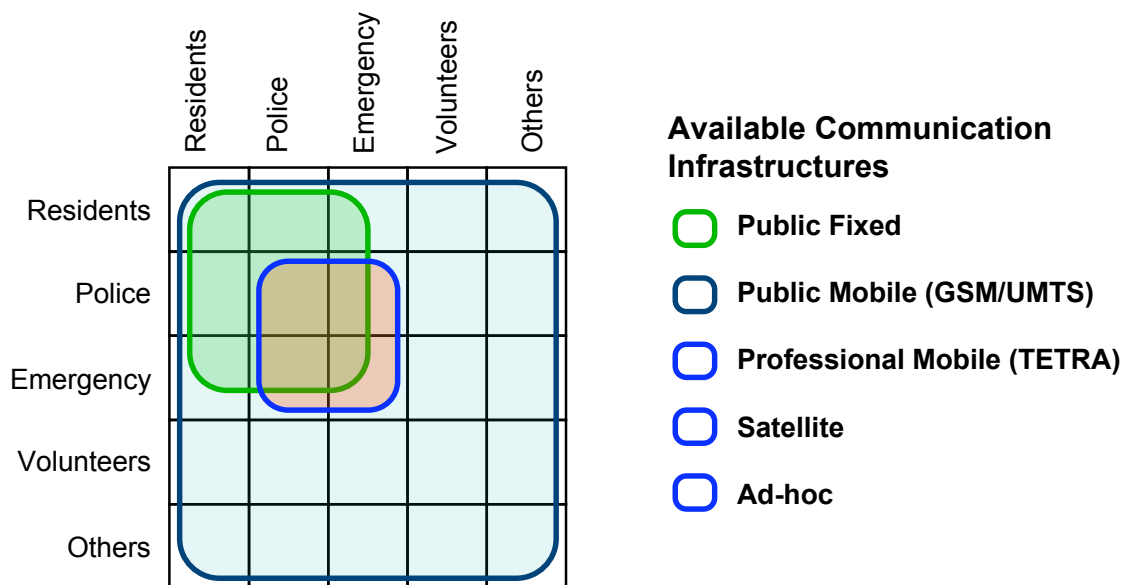

10/09/07

29

Environmental Emergencies

Relative resilience of critical infrastructure types



Type of Infrastructure	Level of Replication	Recovery Time
Buildings	low	months-years
Roads	low	days-months
Railways	none	days-months
Water	none	days-months
Gas	none	days-months
Electricity	none	hours-days
Telecomm's, fixed	low	hours-days
Telecomm's, mobile	high ¹	hours-days
Television	high ¹	minutes-hours
Radio	high ¹	minutes-hours

¹ at least two physically independent infrastructures

10/09/07

30

Communicating During Emergencies

Exploiting the full potential of Public Mobile Networks



❖ Intrinsic resilience to major infrastructural damages

- The existence of multiple independent access infrastructures (*possibly more than one for each operator*) intrinsically reduces the probability of total loss of coverage
- Emergency calls are always possible if at least one network is available (*i.e. by removing SIM*)
- Temporary roaming agreements among all involved operators (*though limited in time and space*) allow damaged networks to complement each other during repair and repair works to be prioritized in order to accelerate ubiquitous service availability
- Radio-relayed movable base stations (*normally used for coverage intensification*) can be quickly deployed to fill coverage gaps where needed

10/09/07

31

Communicating During Emergencies

Exploiting the full potential of Public Mobile Networks



❖ Census, tracing and assistance of residents and visitors

- Almost 100% of the active population in developed Countries owns at least one mobile phone and 90% uses it regularly (*penetration in less developed Countries is fast growing worldwide*)
- Visitor Location Registers (VLR) contain the SIM numbers that are (*and last were*) registered within a given network cell
- SIM numbers can be cross referenced with personal registry data to identify individuals that supposedly are inside the affected and respect areas and to locate them (*at least to 911 specifications*)
- Location sensitive directions and information (*e.g. on best route out of affected area*) could be sent selectively to individuals and groups within a specific area; functional calls (*e.g. medical assistance requests*) could be automatically routed to closest emergency unit available
- All individuals entering or leaving the emergency areas with a mobile phone could be immediately detected, localized, identified, classified and handled accordingly

10/09/07

32

Communicating During Emergencies

Exploiting the full potential of Public Mobile Networks



❖ Traffic management and environmental control

- Generic inbound traffic can be temporarily re-routed to an Emergency Management Call Center to avoid network congestion
- All traffic originating or terminating within specific cells can be partly or totally inhibited on the basis of predefined criteria (*e.g. authorized personnel only*)
- All traffic (*except emergency calls*) relevant to individuals who enter the affected area without authorization can be partly or totally inhibited (*even after leaving area and until cleared by police*)
- All traffic relevant to emergency management forces could be given higher priority depending on specific tasks and responsibilities
- The availability of a reliable wireless access network allows to quickly deploy all kind of remotely controlled monitoring and security equipment such as:
 - *(intelligent) sensors and actuators*
 - *wireless cameras and alarms signals*
 - *public access points*
 - ...

10/09/07

33

Beyond NGN

Infrastructure sharing and separation of operator roles

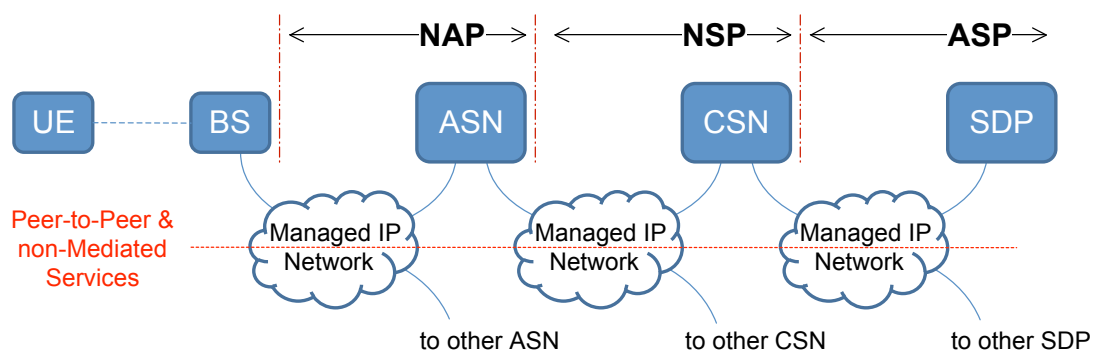

UE:	User Equipment	NAP:	Network Access Provider
BS:	Base Station	NSP:	Network Service Provider
ASN:	Access Service Network	ASP:	Application Service Provider
CSN:	Connectivity Service Network		
SDP:	Service Delivery Platform		

10/09/07

34

Beyond NGN

Evolution of (fixed) access technologies

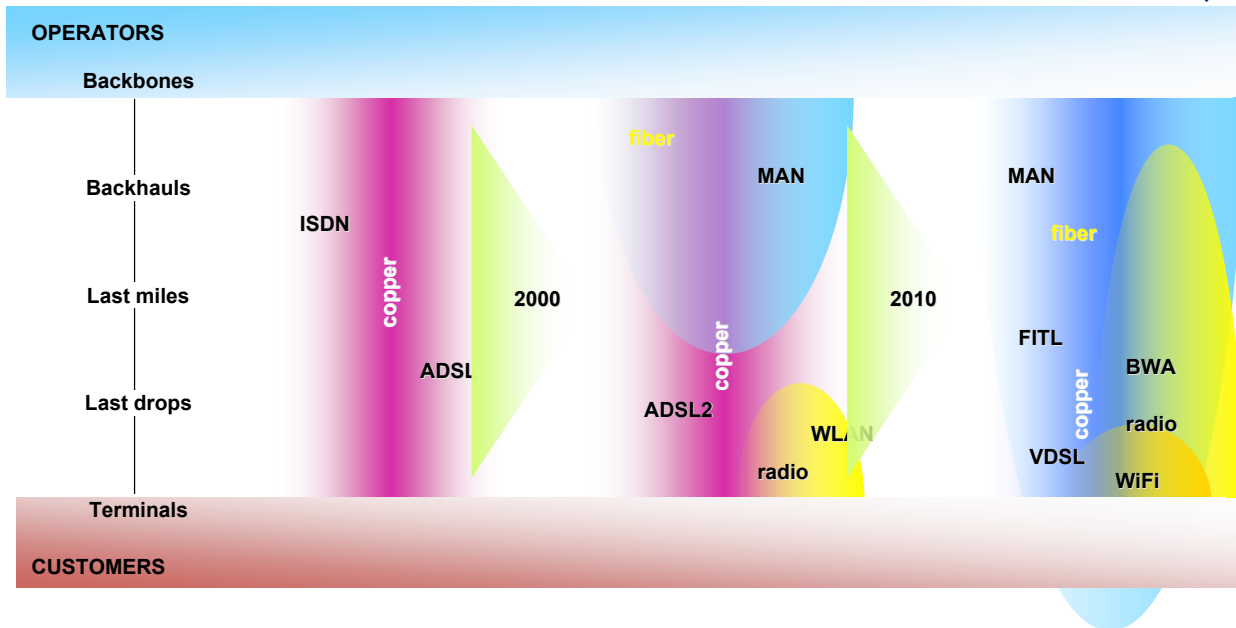

10/09/07

35

Beyond NGN

Fiber based broadband access (PON)

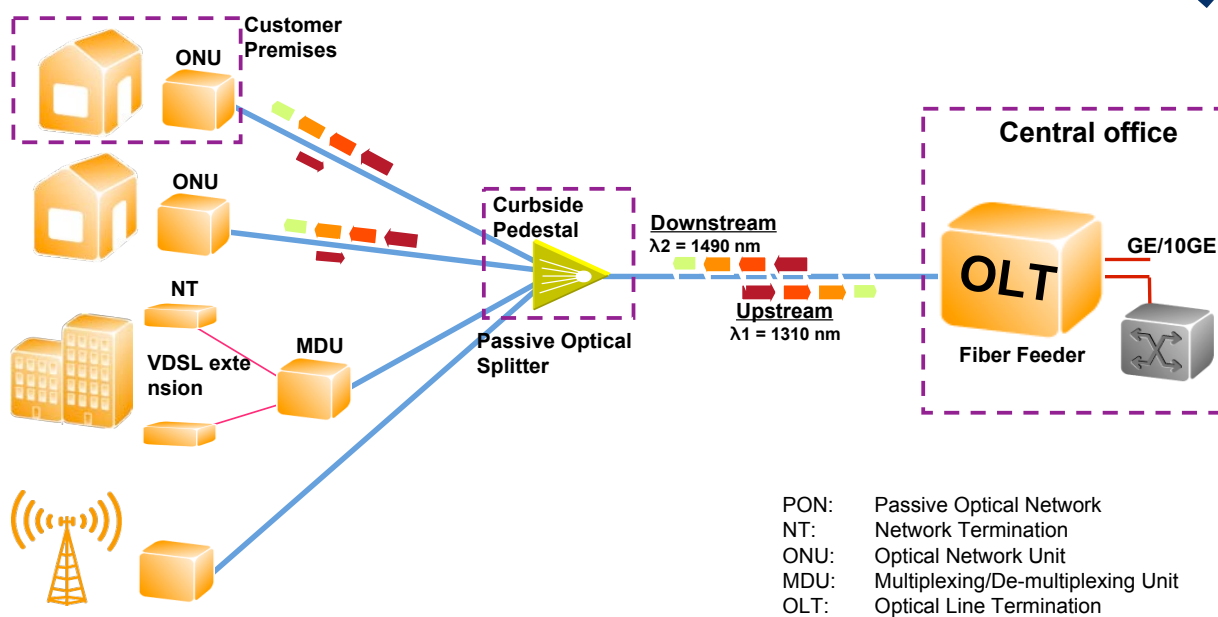

- PON: Passive Optical Network
- NT: Network Termination
- ONU: Optical Network Unit
- MDU: Multiplexing/De-multiplexing Unit
- OLT: Optical Line Termination

10/09/07

36

Beyond NGN

Radio based broadband access



Radio Access Capacity Growth Trend

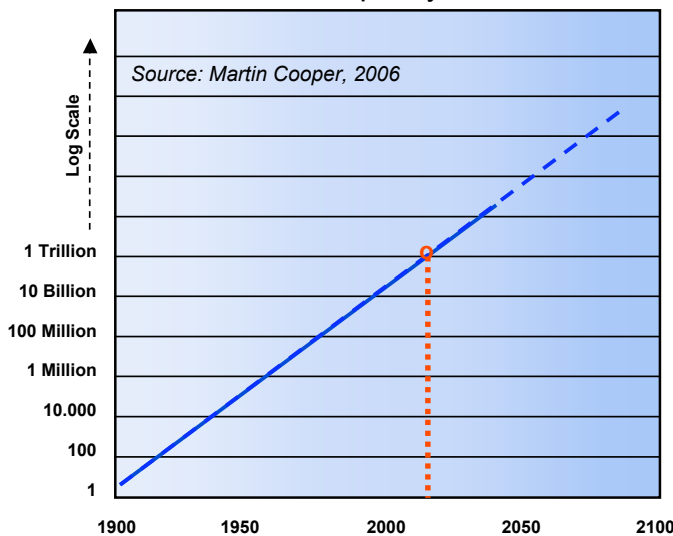

- ❖ QPSK, 16QAM, 64QAM, 256QAM
- ❖ TDMA, FDMA, CDMA, (S)OFDMA
- ❖ SISO, SIMO, MIMO, Beam Forming, Spatial Radio
- ❖ FDD, TDD, Dynamic Spectrum Allocation, **Cognitive Radio**
- ❖ Macro, Micro, Pico, Femto Cells
- ❖ Cellular, **Mesh**, Self-Configuring architectures

Commercial capacities of 1Tbit/s per km² are expected within the next 10 years

Beyond NGN

Towards cognitive radio and dynamic agnostic spectrum allocation

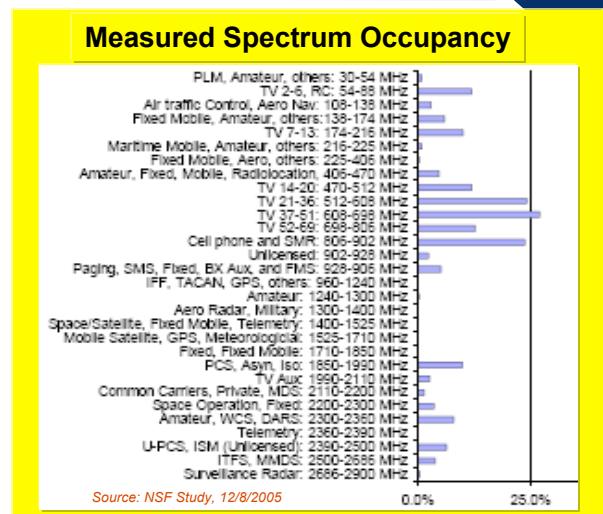
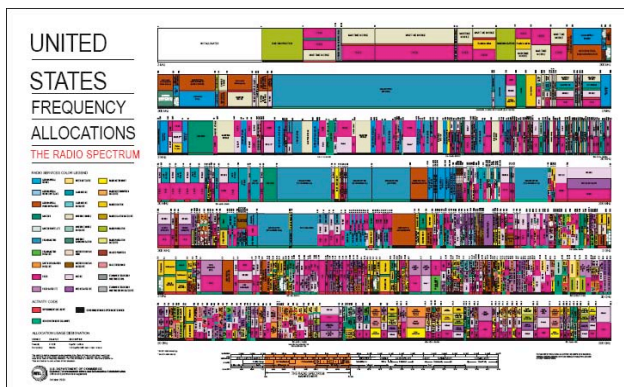

In spite of apparent overcrowding Radio Spectrum is in practice little/poorly used:

- Licensed bands not yet assigned and underutilized
- Poor usage of non-licensed bands
- Frequency reuse and guard bandwidth constraints for interference avoidance

In most Digital Divide areas actual Spectrum usage remains well below 1%

According to a number of recent studies (e.g. by NSF) even in high density urban areas (e.g. New York City) spectrum utilization is very low (e.g. <5% in the .5-2.9GHz Range)

Beyond NGN

Mesh radio networks

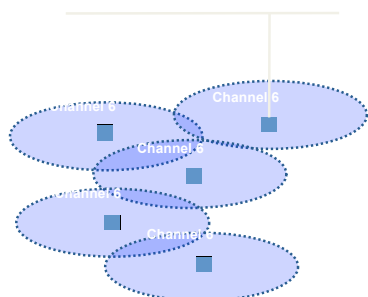

Single radio
 Shared - M2M
 Lowest cost to cover
 Best effort data services

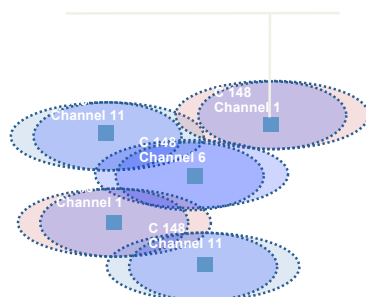

Dual radio
 Shared - M2M
 Compromise
 Data and some voice

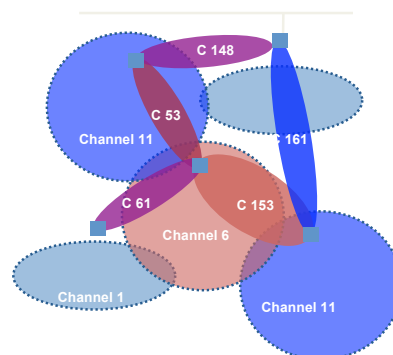

Multi radio
 Switched - mP2P
 Highest performance
 Multi-media services

Not all meshes are created equal !

Summary and Conclusions

From PSTN to NGN



- ❖ Until the 1990's the evolution of public telecommunication networks was mainly driven by technology and controlled by regulators and engineers, with limited attention to actual market expectations and costs
- ❖ Since liberalization these drivers were fast replaced by market and financial related ones; this forced operators to reconsider all assumptions, including many previous musts about dependability and QoS
- ❖ Early Mobile Networks and Internet experience, in particular, proved that dependability and QoS can definitely be traded for higher valued features (e.g. mobility) or even just lower prices (e.g. VoIP)
- ❖ Under the pressure of competition and margin erosion, and thanks to the relaxation of regulations and to a substantial lack of customer reactions, infrastructural resilience progressively lost its importance
- ❖ Although network manufacturers continued to design high dependability equipment for high quality networks, this eventually had to be made into an option, not necessarily required nor implemented by all operators

Summary and Conclusions

Public communications resilience today



- ❖ Although the dependability and QoS of some of the new infrastructures may not be to the level of old telephone networks, this is at least partly compensated by their number and their diversity
- ❖ It is in fact extremely unlikely that a single event, even if catastrophic and of significant geographical extensions, could make all available networks fail at the same time
- ❖ The cellular radio coverage provided by Mobile Networks, in particular, protects them from most sources of infrastructural damage, makes them easy and quick to recover, and is best suited for communicating with and between people who were forced to leave their residence
- ❖ In addition, the user location, identification and tracking capabilities of modern mobile networks can support a large variety of emergency specific services as well as sophisticated traffic management policies
- ❖ The full exploitation of this potential is however more and more subject to the availability of multi-standard terminals capable of interworking with all networks and operators

10/09/07

41

Summary and Conclusions

Beyond NGN



- ❖ Today's NGN architecture is still largely focused on the integration of all services and technologies into one single layered network; as liberalization continues and market consolidates, however, it becomes more and more evident that the future challenge will be to split and share such a network infrastructure among a multiplicity of operators and service providers, most of them specializing in one particular service or technology
- ❖ In the access, fiber optics and radio technologies are due to completely replace copper within just a decade; particularly in the case of radio this will pose significant challenges to achieve the capacity and performances required by broadband; in this respect, cognitive radio should allow a more effective usage and the dynamic allocation of the scarce spectrum resource, whereas mesh radio should provide much higher flexibility and efficiency of coverage
- ❖ Overall, an even greater multiplicity and diversity of technologies and infrastructures is to be expected; hence, the role of terminals in managing this complexity and ensuring interoperability will also be reinforced

10/09/07

42